



WINMAN[®]

güce yön verin...
lead the power...



HİDROLİK

ÜRÜN

KATALOĞU

Hydraulic Product Catalog



hidtek

Hidtek 1987 yılında ülkemizin önemli endüstri şehirlerinden olan Bursa'da faaliyetine başladı.

Başlangıçta hidrolik, pnömatik malzeme satışı ve taahhüt işleri yapan firmamız, ilerleyen zamanda hızla gelişerek ithalat ve ihracat ile birlikte otomasyon ekipmanları ve pnömatik silindir imalatını da faaliyet alanlarına dahil etti.

Markalaşma, pazarlama ve satış ağını geliştirme konularına da önem vererek **WINMAN** ve **FREEWAY** markalarını oluşturdu. Buna paralel olarak, yurtiçinde ve yurtdışında her geçen gün satış ağını genişletmeye devam etti.

Üretim konusunda kurduğu Ar-ge merkezi ile geleceğe ve sürekli gelişen teknolojiye bugüne kadar olduğu gibi bundan sonrada ayak uydurmak kararlılığındadır.

Üretim ve satışı yapılan malzemelerin genel kullanım alanları şunlardır:

- Otomotiv sanayi
- Makine sanayi
- Ambalaj makineleri
- PVC işleme makineleri
- Kaldırma makineleri (asansör, lift)
- Sac işleme makineleri
- Hidrolik presler
- İş makineleri
- Tarım makineleri
- Özel amaçlı makine ve aparatlar

Firmamız, katalogta yayınlanan resim, ölçü ve diğer değerleri değiştirme hakkına sahiptir.

Hidtek started its operations in 1987 in Bursa which is one of the most important industrial cities of our country.

At the beginning, our company was engaged in hydraulic, pneumatic material sales and contract works. Later on, it has been developed rapidly, so included production of automation equipment and pneumatic cylinders right along with import and export.

WINMAN and **FREEWAY** brands are created besides attaching importance to branding, marketing and enhancing sales network. Concordantly, Hidtek has extended its domestic and foreign sales network day by day.

Hidtek is determined to keep up with the future and ever-growing technology as it always has been by means of the R&D center established on production.

General usage areas of the production and sales materials are:

- Automotive industry
- Machine industry
- Packaging machines
- PVC profile processing machines
- Hoisting machinery (elevator, lift)
- Sheet metal working machines
- Hydraulic presses
- Heavy construction equipment
- Agricultural machines
- Custom-made machines and equipment

Our company reserves the right to modify photos, measurements and other values that were published in the catalog.

W WINMAN

WINMAN Oransal Yön Kontrol Valfleri Proportional Directional Control Valves

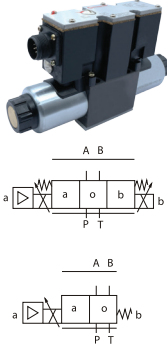

Ölçü Size	Maksimum Debi Maximum Flow
NG 6	7 lt/dk <i>l/min</i>
NG 6	15 lt/dk <i>l/min</i>
NG 6	30 lt/dk <i>l/min</i>
NG 10	30 lt/dk <i>l/min</i>
NG 10	60 lt/dk <i>l/min</i>

WINMAN Oransal Yön Kontrol Valfleri Proportional Directional Control Valves

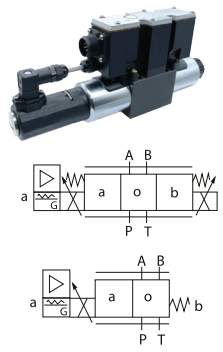

Ölçü Size	Maksimum Debi Maximum Flow
NG 6	8 lt/dk <i>l/min</i>
NG 6	16 lt/dk <i>l/min</i>
NG 6	32 lt/dk <i>l/min</i>
NG 10	25 lt/dk <i>l/min</i>
NG 10	50 lt/dk <i>l/min</i>
NG 10	75 lt/dk <i>l/min</i>

WINMAN Oransal Basınç ve Hız Kontrol Valfleri Proportional Relief and Flow Control Valves

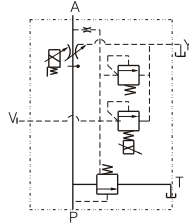

Model / Model	WFBG-02-*.*	WFBG-03-*.*	WFBG-06-250-*
Maksimum Basınç (bar) Maximum Pressure (bar)	315		
Maksimum Debi (lt/dk) Maximum Flow (l/min)	40	160	250
Akış Aralığı (lt/dk) Flow Range (l/min)	1-40	2-160	3-250

WINMAN Oransal Basınç Kontrol Valfleri Proportional Pressure Control Valves

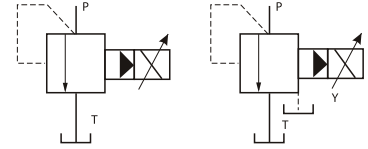

Model / Model	03	06	10
Maksimum Basınç (bar) Maximum Pressure (bar)	315	315	315
Maksimum Debi (lt/dk) Maximum Flow (l/min)	100	200	400

WINMAN Oransal Basınç Kontrol Valfleri Proportional Pressure Control Valves

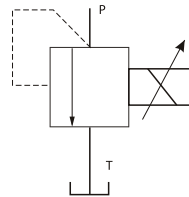
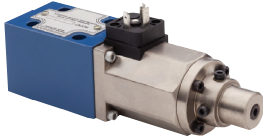

Maksimum Basınç Maximum Pressure	Maksimum Debi Maximum Flow	Akış Aralığı Flow range
315 bar	2 lt/dk <i>l/min</i>	0.7 lt/dk <i>l/min</i>

WINMAN Oransal Basınç Kontrol Valfleri Proportional Pressure Control Valves

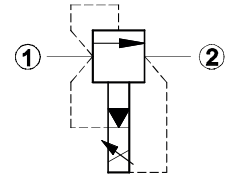

Model Numarası Model Number	Maksimum Debi (lt/dk) Maximum Flow (l/min)
WVR-10	120

WINMAN Oransal Hız Kontrol Valfleri Proportional Flow Control Valves

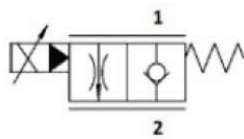

Maksimum Debi Maximum Flow
30 lt/dk <i>l/min</i>

WINMAN Oransal Kart ve Soketler Proportional Valve Driver and Sockets

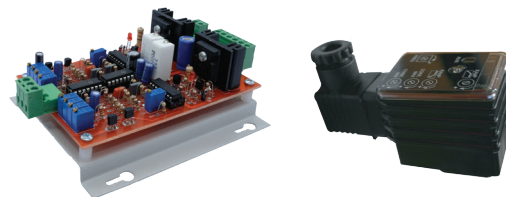

P&Q kartı, P kartı Feedbackli, Q kartı Feedbackli, yön ve hız kartları mevcuttur.

P&Q card, P card with Feedback, Q card with Feedback, direction and speed cards are available.

WINMAN Solenoid Valfler / Solenoid Valves



NG6, NG10, NG16, NG25, NG32 seçenekleri
 12V DC, 24V DC, 110V AC, 220V AC bobin voltaj seçenekleri
 Tek ve çift bobin seçenekleri mevcuttur.
 NG6, NG10, NG16, NG25, NG32 options
 12V DC, 24V DC, 110V AC, 220V AC coil voltage options
 Single and double coil options are available.

Ölçü Size
NG 6
NG 10
NG 16
NG 25
NG 32

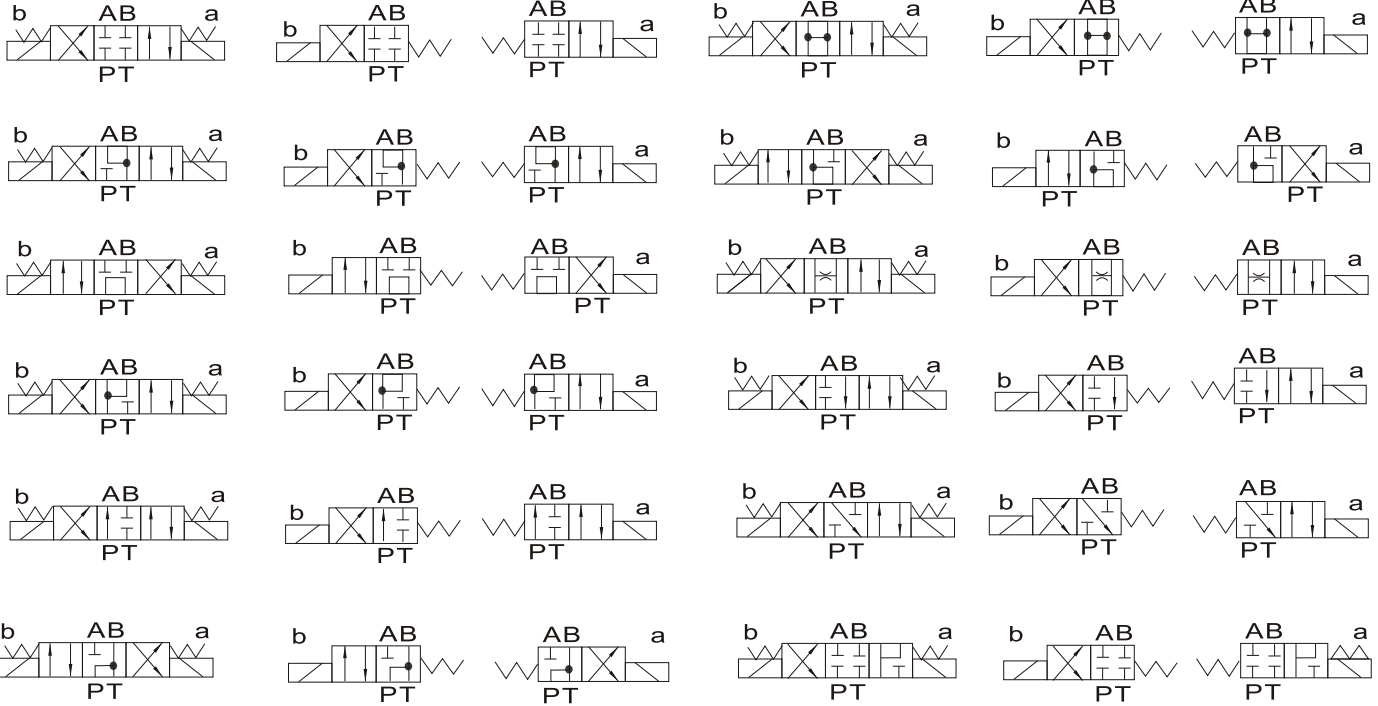

WINMAN Switchli Yön Kontrol Valfleri
Directional Control Valves with Switch

WINMAN Valf Pleytleri
Subplates

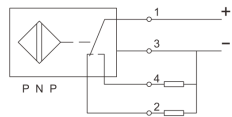

NG 6, NG 10 emniyetli, emniyetsiz, alüminyum ve çelik seçenekleri mevcuttur.
 NG 6, NG 10, with cartridge, without cartridge, aluminium and steel options are available.
 Not: Özel blok imalatımız mevcuttur.
 Note: We can manufacture special blocks.

WINMAN Hat Tipi Basınç Emniyet Valfleri
In-Line Pressure Relief Valves

WINMAN Pleyt Tipi Basınç Emniyet Valfleri
Subplate Type Pressure Relief Valves

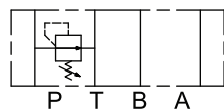

Ölçü Size	Maksimum Debi Maximum Flow
3/4	200 lt/dk /lmin

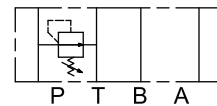

Ölçü Size
NG 10
NG 16
NG 20

WINMAN Switchli Yön Kontrol Valfleri
Directional Control Valves with Switch

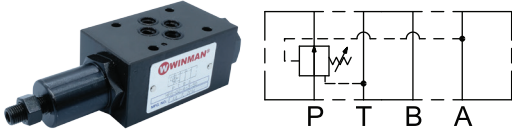

Ölçü Size	Mak. Debi Max. Flow	Mak. Basınç Max. Pressure	Hat Function Port
NG 6	40 lt/dk <i>l/min</i>	250 bar	A,B,P
NG 10	70 lt/dk <i>l/min</i>	250 bar	A,B,P

WINMAN Modüler Valfler (Kilitleme)
Modular Valves (Locking)

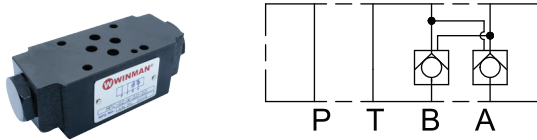

Ölçü Size	Mak. Debi Max. Flow	Mak. Basınç Max. Pressure	Hat Function Port
NG6	40 lt/dk <i>l/min</i>	250 bar	A,B,İKİZ TWIN
NG10	70 lt/dk <i>l/min</i>	250 bar	A,B,İKİZ TWIN
NG16	120 lt/dk <i>l/min</i>	210 bar	İKİZ TWIN
NG25	160 lt/dk <i>l/min</i>	210 bar	İKİZ TWIN

WINMAN Modüler Emniyet Valfleri
Modular Relief Valves

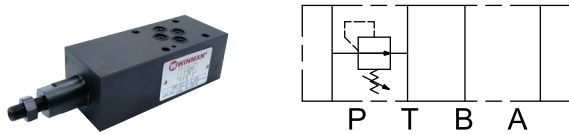

Ölçü Size	Mak. Debi Max. Flow	Mak. Basınç Max. Pressure	Hat Function Port
NG6	40 lt/dk <i>l/min</i>	250 bar	A,P,B,A-B
NG10	70 lt/dk <i>l/min</i>	250 bar	A,P,B,A-B

WINMAN Pleyt Tipi Karşı Denge (Yük Tutma) Valfleri
Subplate Type Counterbalance Valves



Ölçü Size	Mak. Debi Max. Flow	Mak. Basınç Max. Pressure
03	50 lt/dk <i>l/min</i>	70-140 bar
06	125 lt/dk <i>l/min</i>	70-140 bar
10	250 lt/dk <i>l/min</i>	70-140 bar

WINMAN Valf Pleytleri
Subplates



Ölçü Size	Mak. Debi Max. Flow	Mak. Basınç Max. Pressure	Hat Function Port
NG 6	40 lt/dk <i>l/min</i>	250 bar	A,B,İKİZ TWIN
NG 10	70 lt/dk <i>l/min</i>	250 bar	A,B,İKİZ TWIN

WINMAN Modüler Çekvalfler
Modular Check Valves

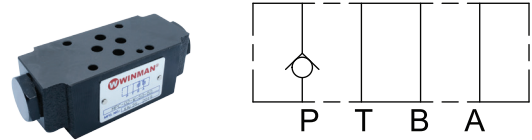

Ölçü Size	Mak. Debi Max. Flow	Mak. Basınç Max. Pressure	Hat Function Port
NG6	40lt/dk <i>l/min</i>	250 bar	P,A

WINMAN Pleyt Tipi Modüler Çekvalfler
Subplate Type Modular Check Valves



Ölçü Size	Mak. Debi Max. Flow	Mak. Basınç Max. Pressure
06	125 lt/dk <i>l/min</i>	250 bar
10	250 lt/dk <i>l/min</i>	250 bar

WINMAN Pleyt Tipi Modüler Hız Ayar Valfleri
Subplate Type Modular Flow Control Valves



Ölçü Size	Mak. Debi Max. Flow	Mak. Basınç Max. Pressure
03	30 lt/dk <i>l/min</i>	250 bar
06	80 lt/dk <i>l/min</i>	250 bar
10	200 lt/dk <i>l/min</i>	250 bar

WINMAN Kartriç Emniyet Valfleri
Cartridge Relief Valves

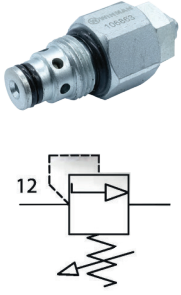

Kavite Cavity	Mak. Debi Max. Flow
M20X1,5	10 lt/dk <i>l/min</i>
3/4-16UNF	20 lt/dk <i>l/min</i>
M18X1,5	20 lt/dk <i>l/min</i>
M22X1,5	45 lt/dk <i>l/min</i>
M24X1,5	80 lt/dk <i>l/min</i>

WINMAN Kartriç Emniyet Valfleri
Cartridge Relief Valves

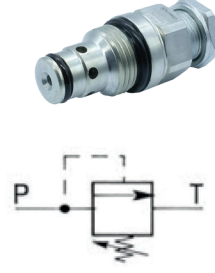

Kavite Cavity	Mak. Debi Max. Flow
SAE 08	30 lt/dk <i>l/min</i>
3/4-16UNF	40 lt/dk <i>l/min</i>
SAE 10	120 lt/dk <i>l/min</i>
M 28	250 lt/dk <i>l/min</i>

WINMAN Kartriç Basınç Emniyet Valfleri
Cartridge Pressure Relief Valves

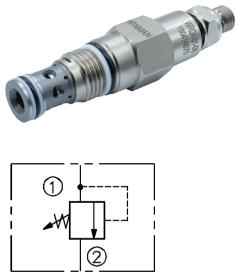

Kavite Cavity	Mak. Debi Max. Flow
T-162-A	45 lt/dk <i>l/min</i>
T-10-A	100 lt/dk <i>l/min</i>
T-3-A	200 lt/dk <i>l/min</i>
T-16-A	380 lt/dk <i>l/min</i>
T-18-A	760 lt/dk <i>l/min</i>

Not: Ayar aralıkları için bilgi alınız.
Note: Request information for the setting ranges.

WINMAN Kartriç Pilot Kumandalı Basınç Emniyet Valfleri
WINMAN Cartridge Pilot Operated Pressure Relief Valves

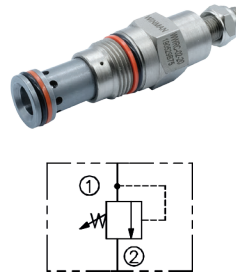

Kavite Cavity	Mak. Debi Max. Flow
T-10-A	100 lt/dk <i>l/min</i>
T-3-A	200 lt/dk <i>l/min</i>
T-16-A	380 lt/dk <i>l/min</i>
T-18-A	760 lt/dk <i>l/min</i>

Not: Ayar aralıkları için bilgi alınız.
Note: Request information for the setting ranges.

WINMAN Kartriç Dıştan Pilot Kumandalı Basınç Emniyet Valfleri
Cartridge External Pilot Operated Pressure Relief Valves

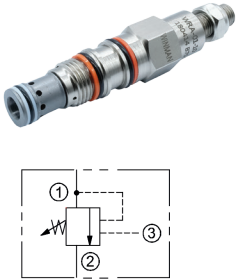

Kavite Cavity	Mak. Debi Max. Flow
T-163-A	30 lt/dk <i>l/min</i>
T-11-A	60 lt/dk <i>l/min</i>
T-2-A	120 lt/dk <i>l/min</i>
T-17-A	240 lt/dk <i>l/min</i>
T-19-A	480 lt/dk <i>l/min</i>

Not: Ayar aralıkları için bilgi alınız.
Note: Request information for the setting ranges.

WINMAN Kartriç Basınç Sıralama Valfleri
Cartridge Pressure Sequence Valves

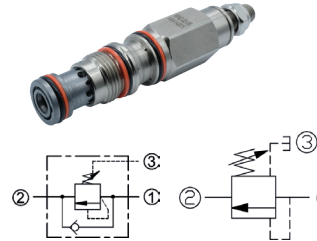

Kavite Cavity	Mak. Debi Max. Flow
T-11-A	60 lt/dk <i>l/min</i>
T-2-A	120 lt/dk <i>l/min</i>
T-17-A	240 lt/dk <i>l/min</i>
T-19-A	480 lt/dk <i>l/min</i>

Not: Ayar aralıkları için bilgi alınız.
Çekli ve çeksiz seçenekleri bulunmaktadır.
Note: Request information for the setting ranges.
With or without check options are available.

WINMAN Kartriç Basınç Düşürücü Valfler
WINMAN Cartridge Pressure Reducing Valves

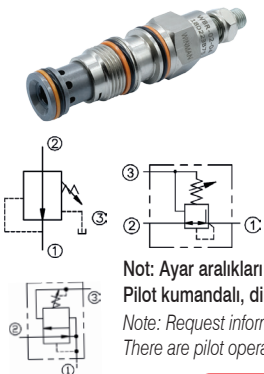

Kavite Cavity	Mak. Debi Max. Flow
T-11-A	40 lt/dk <i>l/min</i>
T-2-A	80 lt/dk <i>l/min</i>
T-17-A	160 lt/dk <i>l/min</i>
T-19-A	320 lt/dk <i>l/min</i>

Not: Ayar aralıkları için bilgi alınız.
Pilot kumandalı, direkt etkili ve çift geçişli seçenekleri bulunmaktadır.
Note: Request information for the setting ranges.
There are pilot operated, direct acting and bidirectional flow options.

WINMAN Kartriç Karşı Denge (Yük Tutma) Valfleri
Cartridge Counterbalance Valves

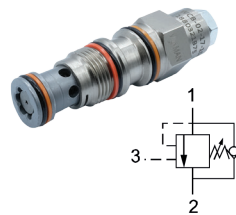

Kavite Cavity	Mak. Debi Max. Flow
T-11-A	40 lt/dk <i>l/min</i>
T-2-A	80 lt/dk <i>l/min</i>
T-17-A	240 lt/dk <i>l/min</i>

Not: Ayar aralıkları için bilgi alınız.
Açma basıncı 1,8 bardır.
Açma basıncı 0,3 bar için bilgi alınız.
Note: Request information for the setting ranges.
Opening pressure is 1.8 bar.
Obtain information for the opening pressure 0.3 bar.

WINMAN Kartriç Pilot Kumandalı Çekvalfler Cartridge Pilot Operated Check Valves

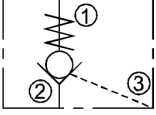

Kavite Cavity	Mak. Debi Max. Flow
T-163-A	30 lt/dk <i>l/min</i>
T-11-A	120 lt/dk <i>l/min</i>
T-2-A	120 lt/dk <i>l/min</i>
T-17-A	200 lt/dk <i>l/min</i>
T-19-A	460 lt/dk <i>l/min</i>
T-2-A	140 lt/dk <i>l/min</i>

Not: Ayar aralıkları için bilgi alınız.
Note: Request information for the setting ranges.

WINMAN Basınç ve Yön Kontrol Lojik Valfleri Pressure and Directional Control Logic Valves

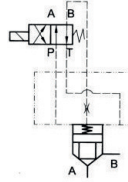

Açma Basıncı Opening Pressure	Basınç Pressure	Mak. Debi Max. Flow
5 bar	315 bar	130 lt/dk <i>l/min</i>
5 bar	315 bar	350 lt/dk <i>l/min</i>
5 bar	315 bar	500 lt/dk <i>l/min</i>
5 bar	315 bar	850 lt/dk <i>l/min</i>
5 bar	315 bar	1400 lt/dk <i>l/min</i>
5 bar	315 bar	2100 lt/dk <i>l/min</i>

Not: Ayar aralıkları için bilgi alınız.
Note: Request information for the setting ranges.

WINMAN Kartriç Çekvalfler Cartridge Check Valves

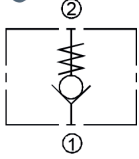

Kavite Cavity	Mak. Debi Max. Flow
T-162-A	40 lt/dk <i>l/min</i>
T-13-A	80 lt/dk <i>l/min</i>
T-5-A	140 lt/dk <i>l/min</i>
T-16-A	320 lt/dk <i>l/min</i>
T-18-A	640 lt/dk <i>l/min</i>

Not: Ayar aralıkları için bilgi alınız.
Note: Request information for the setting ranges.

WINMAN Kartriç Çekli Hız Ayar Valfleri Cartridge Flow Control Valves with Check

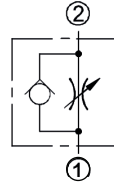

Kavite Cavity	Mak. Debi Max. Flow
T-162-A	15 lt/dk <i>l/min</i>
T-13-A	40 lt/dk <i>l/min</i>
T-5-A	80 lt/dk <i>l/min</i>
T-16-A	160 lt/dk <i>l/min</i>

WINMAN Kartriç Çeksiz Hız Ayar Valfleri Cartridge Flow Control Valves without Check

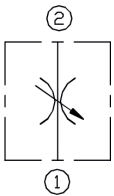

Kavite Cavity	Mak. Debi Max. Flow
T-13-A	35 lt/dk <i>l/min</i>
T-5-A	50 lt/dk <i>l/min</i>
T-16-A	160 lt/dk <i>l/min</i>

WINMAN Kartriç Hız Ayar Valfleri Cartridge Flow Control Valves



Kavite Cavity	Basınç Pressure	Mak. Debi Max. Flow
SAE 08	350 bar	40 lt/dk <i>l/min</i>
M22X1,5	350 bar	45 lt/dk <i>l/min</i>
SAE 10	245 bar	60 lt/dk <i>l/min</i>

Not: Çekli, çeksiz, basınç duyarlı ve üç yollu seçenekleri için bilgi alınız.
Note: Obtain information for with or without check, pressure sensitive and three way options.



WINMAN Bobin ve Soketler / Coils and Sockets



Kare evi 5/13, yuv evi 3/14 tipleri bulunmaktadır. 12V DC, 24V DC, 110V AC, 220V AC seçenekleri bulunmaktadır.
Oransal kartlı soketler için bilgi alınız.

There are square 5/13 and round 3/14 types. There are 12V DC, 24V DC, 110V AC, 220V AC options. Obtain information for sockets with proportional cards.

WINMAN 2/2 Popet Solenoid Valfler
2/2 Poppet Solenoid Valves

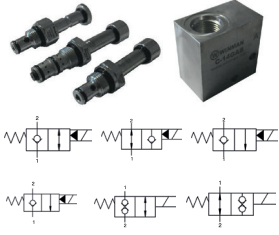

Kavite Cavity	Mak. Debi Max. Flow
SAE 08	40 lt/dk <i>l/min</i>
SAE 10	80 lt/dk <i>l/min</i>
3/4-BSP	80 lt/dk <i>l/min</i>
1-BSP	150 lt/dk <i>l/min</i>

WINMAN 3/2 Popet Solenoid Valfler
3/2 Poppet Solenoid Valves

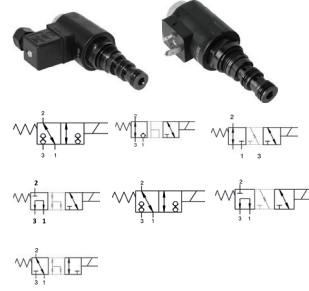

Kavite Cavity	Mak. Debi Max. Flow
SAE 08-02	10 lt/dk <i>l/min</i>
M18	10 lt/dk <i>l/min</i>
7/8-UNF	18 lt/dk <i>l/min</i>
SAE 10-2	20 lt/dk <i>l/min</i>

WINMAN 4/2 - 4/3 Popet Solenoid Valfler / 4/2 - 4/3 Poppet Solenoid Valves



Kavite Cavity	Mak. Debi Max. Flow
SAE 08-03	10 lt/dk <i>l/min</i>
SAE 08-03	12 lt/dk <i>l/min</i>

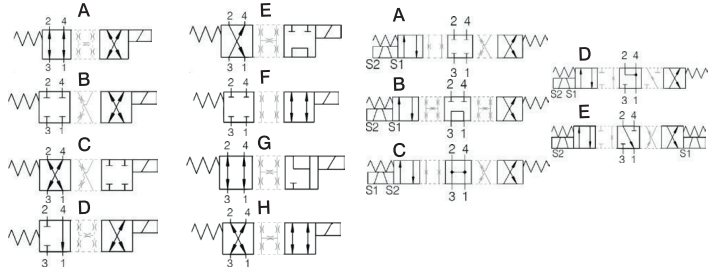

WINMAN® Mobil Valfler / Mobile Valves

WINMAN Hat Tipi Akış Bölücü Valfler
In-Line Flow Divider Valves

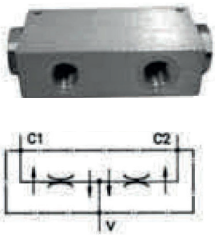

Basınç Pressure	Mak. Debi Max. Flow
210 bar	2-6 lt/dk <i>l/min</i>
210 bar	6,5-11 lt/dk <i>l/min</i>
210 bar	13-22 lt/dk <i>l/min</i>
210 bar	25-38 lt/dk <i>l/min</i>
210 bar	28-55 lt/dk <i>l/min</i>
210 bar	56-95 lt/dk <i>l/min</i>
210 bar	90-150 lt/dk <i>l/min</i>

WINMAN Platform Valfleri
Platform Valves



Port Port	Mak. Debi Max. Flow
1/4	20 lt/dk <i>l/min</i>
3/8	40 lt/dk <i>l/min</i>
1/2	60 lt/dk <i>l/min</i>
3/4	80 lt/dk <i>l/min</i>

WINMAN Tandem Sıfırlama Valfleri
Tandem Unloading Valves

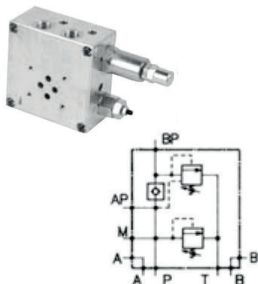

Basınç Pressure	Mak. Debi Max. Flow
350 bar	60 lt/dk <i>l/min</i>
350 bar	90 lt/dk <i>l/min</i>
350 bar	120 lt/dk <i>l/min</i>

WINMAN Hat Tipi 3 Yollu Akış Bölücü Valfleri
In-Line 3 Way Flow Control Valves

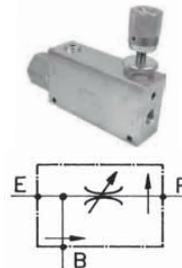

Ölçü Size	Basınç Pressure	Mak. Debi Max. Flow
3/8	350 bar	35-55 lt/dk <i>l/min</i>
1/2	350 bar	55-90 lt/dk <i>l/min</i>
3/4	350 bar	90-150 lt/dk <i>l/min</i>

WINMAN Hat Tipi Tekli Karşı Denge (Yük Tutma) Valfleri
In-Line Single Acting Counterbalance Valves

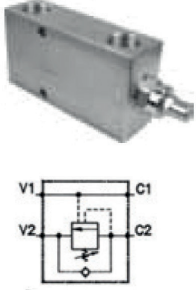

Mak. Basınç Max. Pressure	Mak. Debi Max. Flow
350 bar	40 lt/dk <i>l/min</i>
350 bar	60 lt/dk <i>l/min</i>
350 bar	120 lt/dk <i>l/min</i>
350 bar	160 lt/dk <i>l/min</i>

WINMAN Hat Tipi İkiz Karşı Denge (Yük Tutma) Valfleri
In-Line Double Acting Counter Balance Valves

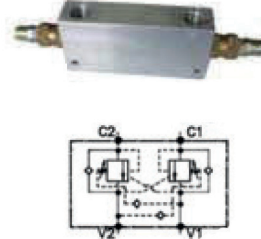

Mak. Basınç Max. Pressure	Mak. Debi Max. Flow
350 bar	40 lt/dk <i>l/min</i>
350 bar	60 lt/dk <i>l/min</i>
350 bar	120 lt/dk <i>l/min</i>
350 bar	160 lt/dk <i>l/min</i>

WINMAN Hat Tipi Karşı Denge (Yük Tutma) Valfleri (Banjo)
In-Line Counterbalance Valves (Banjo)

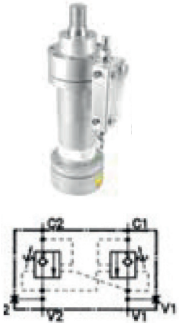

Mak. Basınç Max. Pressure	Mak. Debi Max. Flow
350 bar	40 lt/dk <i>l/min</i>
350 bar	60 lt/dk <i>l/min</i>

WINMAN Motor Tipi Karşı Denge (Yük Tutma) Valfleri
Engine Type Counterbalance Valves

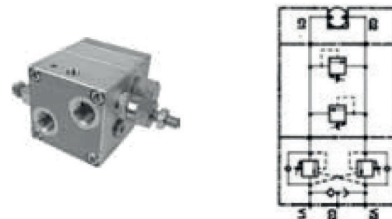

Mak. Debi Max. Flow
60 lt/dk <i>l/min</i>

WINMAN Hat Tipi Direkt Emniyet Valfleri
WINMAN In-Line Direct Acting Relief Valves



Mak. Basınç Max. Pressure	Mak. Debi Max. Flow
210 bar	20 lt/dk <i>l/min</i>
210 bar	40 lt/dk <i>l/min</i>
210 bar	80 lt/dk <i>l/min</i>
210 bar	120 lt/dk <i>l/min</i>

WINMAN İkiz Emniyet Valfleri
Double Acting Relief Valves

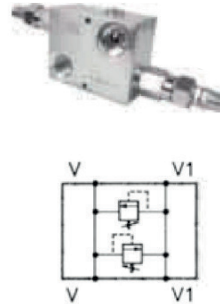

Mak. Basınç Max. Pressure	Mak. Debi Max. Flow
350 bar	35 lt/dk <i>l/min</i>
350 bar	40 lt/dk <i>l/min</i>
350 bar	80 lt/dk <i>l/min</i>

WINMAN Basınç Sıralama Valfleri
Pressure Sequence Valves

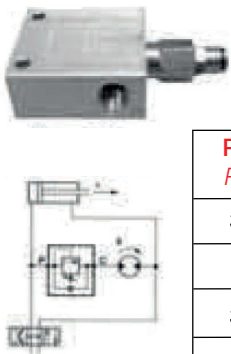

Port Port	Mak. Basınç Max. Pressure	Mak. Debi Max. Flow
3/8	350 bar	40 lt/dk <i>l/min</i>
1/2	350 bar	60 lt/dk <i>l/min</i>
3/4	350 bar	120 lt/dk <i>l/min</i>
1	350 bar	160 lt/dk <i>l/min</i>

WINMAN Hat Tipi Basınç Düşürücü Valf
In-Line Pressure Reducing Valve

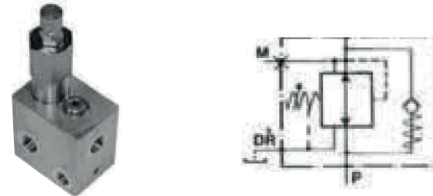

Port Port	Mak. Basınç Max. Pressure	Mak. Debi Max. Flow
3/8	350 bar	45 lt/dk <i>l/min</i>

WINMAN Akış Kontrol Valfleri

In-Line Single Acting Counterbalance Valves

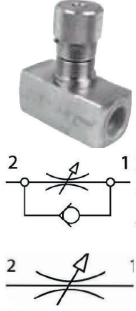

Ölçü Size	Mak. Basınç Max. Pressure	Mak. Debi Max. Flow
1/4	400 bar	15 lt/dk <i>l/min</i>
3/8	400 bar	30 lt/dk <i>l/min</i>
1/2	400 bar	50 lt/dk <i>l/min</i>
3/4	400 bar	85 lt/dk <i>l/min</i>
1	400 bar	150 lt/dk <i>l/min</i>

Not: Çekli, çeksiz, basınç duyarlı ve üç yollu seçenekleri için bilgi alınız.
Note: Obtain information for with check, without check, pressure sensitive and three way options.

WINMAN Çekvalfler

WINMAN Check Valves



Ölçü Size	Mak. Basınç Max. Pressure	Mak. Debi Max. Flow
1/4	350 bar	15 lt/dk <i>l/min</i>
3/8	350 bar	50 lt/dk <i>l/min</i>
1/2	320 bar	50 lt/dk <i>l/min</i>
3/4	300 bar	90 lt/dk <i>l/min</i>
1	250 bar	150 lt/dk <i>l/min</i>
1 1/4	250 bar	200 lt/dk <i>l/min</i>
1 1/2	210 bar	300 lt/dk <i>l/min</i>

Not: Kartriç çekvalfler bulunmaktadır. Note: Cartridge check valves are available.

WINMAN Hat Tipi Pilot Kumandalı Çekvalfler (Kilitleme)

In-Line Pilot Operated Check Valves (Locking)

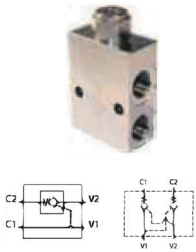

Ölçü Size	Mak. Basınç Max. Pressure	Mak. Debi Max. Flow
1/4	320 bar	15 lt/dk <i>l/min</i>
3/8	320 bar	35 lt/dk <i>l/min</i>
1/2	300 bar	45 lt/dk <i>l/min</i>
3/4	280 bar	70 lt/dk <i>l/min</i>

Not: Tekli, ikiz, face tip, banjo tip çeşitleri bulunmaktadır.
Note: Single acting, double acting, face type and banjo types are available.

WINMAN Döner Elemanlar

Rotary Elements

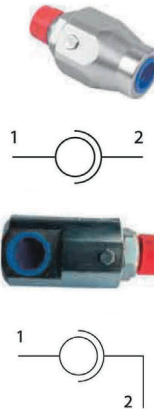

Ölçü Size	Dönüş Hızı Rotation Speed	Mak. Debi Max. Flow
1/4	212 dev/dk <i>rev/min</i>	25 lt/dk <i>l/min</i>
3/8	173 dev/dk <i>rev/min</i>	35 lt/dk <i>l/min</i>
1/2	160 dev/dk <i>rev/min</i>	60 lt/dk <i>l/min</i>
3/4	120 dev/dk <i>rev/min</i>	100 lt/dk <i>l/min</i>
1	100 dev/dk <i>rev/min</i>	180 lt/dk <i>l/min</i>

Not: Düz ve dirsek tipleri bulunmaktadır.
Note: There are straight and elbow types.

WINMAN Hat Tipi İkiz Karşı Denge (Yük Tutma) Valfleri

In-Line Double Acting Counterbalance Valves



Ölçü Size	Mak. Basınç Max. Pressure	Mak. Debi Max. Flow
1/4	350 bar	25 lt/dk <i>l/min</i>
3/8	350 bar	50 lt/dk <i>l/min</i>
1/2	350 bar	80 lt/dk <i>l/min</i>
3/4	350 bar	150 lt/dk <i>l/min</i>
1	350 bar	180 lt/dk <i>l/min</i>

WINMAN Hat Tipi Pilot Kumandalı Çekvalfler (Kilitleme)

In-Line Pilot Operated Check Valves (Locking)



Ölçü Size	Mak. Basınç Max. Pressure	Mak. Debi Max. Flow
1/4	320 bar	15 lt/dk <i>l/min</i>
3/8	320 bar	35 lt/dk <i>l/min</i>
1/2	300 bar	45 lt/dk <i>l/min</i>
3/4	280 bar	70 lt/dk <i>l/min</i>

WINMAN El Pompaları

Hand Pumps

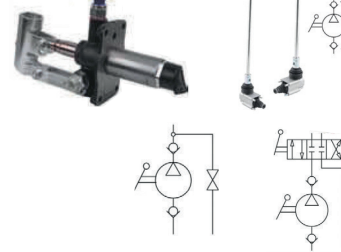

Kapasite cm ³ Capacity	Mak. Basınç Max. Pressure
12	350 bar
25	350 bar
45	280 bar

Not: Popet tip, tek etkili ve çift etkili çeşitleri bulunmaktadır.
Note: There are poppet type, single acting and double acting varieties.

WINMAN Küresel Vanalar

Ball Valves



Not: 304 kalite paslanmaz ve 2 yollu seçenekleri vardır.
2 yollu boru bağlantılı ve pleyt tipi seçenekleri vardır.
Note: There are 304 quality stainless and 2-way options.
2-way pipe connection and plate type options are available.

Ölçü Size	Mak. Basınç Max. Pressure
1/4	500 bar
3/8	500 bar
1/2	400 bar
3/4	315 bar
1	315 bar
1 1/4	315 bar
1 1/2	315 bar
2	315 bar

WINMAN Dişli Pompalar

Gear Pumps

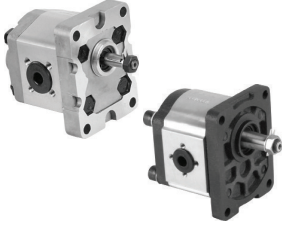

Alüminyum gövde
0PF, 1PF, 2PF ve 3PF gövde ölçülerinde
0.5 cc - 51 cc aralıklarında
Maksimum basınç 250 bar
Tandem ve üçlü pompaya uygun
Aluminium body
Available in 0PF, 1PF, 2PF and 3PF body dimensions
Between 0.5 cc - 51 cc
Maximum pressure 250 bar
Suitable for tandem and triple pump

WINMAN Mini Güç Ünitesi (Power Pack) Pompaları

Power Pack Pumps



Alüminyum gövde
0PF, 1PF, 2PF ve 3PF gövde ölçülerinde
0.5 cc - 51 cc aralıklarında
Maksimum basınç 250 bar
Aluminium body
Available in 0PF, 1PF, 2PF and 3PF body dimensions
From 0.5 cc to 51 cc
Maximum pressure 250 bar

WINMAN WQ Serisi Paletli Pompalar

WQ Series Vane Pumps



8 cc - 75 cc aralıklarında
Maksimum basınç 240 bar
Between 8 cc - 75 cc
Maximum pressure 240 bar

WINMAN Dişli Pompalar

Gear Pumps



Alüminyum gövde
0PF, 1PF, 2PF ve 3PF gövde ölçülerinde
0.5 cc - 51 cc aralıklarında
Maksimum basınç 250 bar
Tandem ve üçlü pompaya uygun
Aluminium body
Available in 0PF, 1PF, 2PF and 3PF body dimensions
From 0.5 cc to 51 cc kısmını
Maximum pressure 250 bar
Suitable for tandem and triple pump

WINMAN Paletli Pompalar

Vane Pumps



Sabit debili ve değişken debili tiplerinde
6cc - 153 cc aralıklarında
Fixed displacement and variable flow types
Between 6cc - 153 cc

Not : Paletli tandem pompalar için bilgi alınız.
Note: Request information for vane tandem pumps.

WINMAN WP1 Serisi Ayarlanabilir Paletli Pompalar

WP1 Series Adjustable Vane Pumps



8 lt - 40 lt aralıklarında
50 - 70 bar çalışma basıncı aralıklarında
Between 8 l - 40 l
50 - 70 bar working pressure ranges

Not : Paletli tandem pompalar için bilgi alınız.
Note: Request information for vane tandem pumps.

WINMAN V Serisi Ayarlanabilir Pistonlu Pompalar

V Series Adjustable Piston Pumps

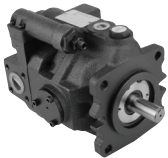

15 cc - 70 cc aralıklarında
20 - 250 bar çalışma basıncı aralıklarında
Between 15 cc - 70 cc
20 - 250 bar working pressure ranges

WINMAN AR Serisi Ayarlanabilir Pistonlu Pompalar

AR Series Adjustable Piston Pumps



16 cc - 22 cc aralıklarında
12 - 210 bar çalışma basıncı aralıklarında
Between 16 cc - 22 cc
12 - 210 bar working pressure ranges

WINMAN WA10V Serisi Ayarlanabilir Pistonlu Pompalar

WA10V Series Adjustable Piston Pumps



28 cc - 140 cc aralıklarında
DR, DFR, DFLR seçenekleri
Between 28 cc - 140 cc
DR, DFR, DFLR options

WINMAN Sabit Debili Pistonlu Pompalar

Fixed Displacement Piston Pumps



45 cc - 80 cc aralıklarında
Maksimum sürekli hız 2200 dev/dk
Between 45 cc - 80 cc
Maximum continuous speed 2200 rev/min

WINMAN PV Serisi Ayarlanabilir Pistonlu Pompalar

PV Series Adjustable Piston Pumps



16 cc - 71 cc aralıklarında
420 bar çalışma basıncı
Between 16 cc - 71 cc
420 bar working pressure

WINMAN Döküm Gövde Dişli Pompalar

Cast Body Gear Pumps



43 cc - 82 cc aralıklarında
Maksimum sürekli hız 1800 dev/dk
Between 43 cc - 82 cc
Maximum continuous speed 1800 rev/min

WINMAN Hidromotorlar
Hydromotors

Orbit ve frenli tipleri bulunmaktadır.
Detaylar için bilgi alınınız.
*Orbit and with brake types are available.
Obtain information for details.*

WINMAN Silindir ve Aksesuarları
Cylinder and Accessories

GK (C) tipi
GK (C) type

GF (S) tipi
GF (S) type



Model : GK, GF ve GIHR tiplerinde
Ölçü : Ø20-25-30-35-40-50-60-70-80-90-100 mm
Diğer silindir aksesuarları mevcuttur bilgi alınınız.
*Model : GK, GF and GIHR types
Size : Ø20-25-30-35-40-50-60-70-80-90-100 mm
Other cylinder accessories are available, please inquire.*

WINMAN Silindir ve Aksesuarları
Cylinder and Accessories

Silindir Tipleri : W1, W2, W3, W4, W5, W6, W7 ve W8
Silindir Ölçüleri : Ø32-40-50-63-80-100-125-140-160-180-200 mm
İstenilen strokta ve basınç değerlerinde üretimimiz mevcuttur.
Not 1: Standart ürünlerin 2D çizimleri ve ölçüleri internet sitemizde mevcuttur, ulaşabilirsiniz.
Not 2: Farklı ölçülerde hidrolik silindir istenildiğinde teknik resim yardımı ile üretilebilir.

*Cylinder Types : W1, W2, W3, W4, W5, W6, W7 and W8
Cylinder Dimensions : Ø32-40-50-63-80-100-125-140-160-180-200 mm
We have production in desired stroke and pressure values.
Note 1: 2D drawings and dimensions of standard products are available on our website.
Note 2: Hydraulic cylinders in different sizes can be produced with the help of technical drawings when requested.*

WINMAN Kısa Kurslu Silindirler
Short Stroke Cylinders

Model : SD (Dik Montajlı) ve LA (Yatık Montajlı)
Silindir İç Çap Ölçüleri: Ø32-40-50-63-80 mm
Not 1: Alüminyum gövde manyetikli çalışma basıncı maksimum 140 bar.
Not 2: İstenildiği takdirde yüksek basınçlı ve çelik manyetiksiz gövde üretimimiz mevcuttur.

*Model : SD (Vertical Mounted) and LA (Horizontal Mounted)
Cylinder Inner Diameter Dimensions: Ø32-40-50-63-80 mm
Note 1: Maximum working pressure of aluminium body magnetic type is 140 bar.
Note 2: If desired, we have high pressure and steel non-magnetic body production.*

WINMAN Kısa Kurslu Silindirler
Short Stroke Cylinders

Model : LA (Yatık Montajlı)
Silindir İç Çap Ölçüleri: Ø32-40-50-63-80 mm
Not 1: Alüminyum gövde manyetikli çalışma basıncı maksimum 140 bar.
Not 2: İstenildiği takdirde yüksek basınçlı ve çelik manyetiksiz gövde üretimimiz mevcuttur.

*Model : LA (Horizontal Mounted)
Cylinder Inner Diameter Dimensions: Ø32-40-50-63-80 mm
Note 1: Maximum working pressure of aluminium body magnetic type is 140 bar.
Note 2: If desired, we have high pressure and steel non-magnetic body production.*

WINMAN Klempler
Clamps

OS1

Model : OS1-SL-SR
OS2-SL-SR
OS4-SL-SR
Ölçü : Ø32-40-50-63 mm

*Model : OS1-SL-SR
OS2-SL-SR
OS4-SL-SR
Size : Ø32-40-50-63 mm*

WINMAN Klempler
Clamps

OS2

Model : OS1-SL-SR
OS2-SL-SR
OS4-SL-SR
Ölçü : Ø32-40-50-63 mm

*Model : OS1-SL-SR
OS2-SL-SR
OS4-SL-SR
Size : Ø32-40-50-63 mm*

WINMAN Klempler
Clamps

Model : OS1-SL-SR
OS2-SL-SR
OS4-SL-SR
Ölçü : Ø32-40-50-63 mm

*Model : OS1-SL-SR
OS2-SL-SR
OS4-SL-SR
Size : Ø32-40-50-63 mm*

OS4

WINMAN Havalı Soğutucular / Air Coolers



Not: 12V DC, 24V DC, 220V AC ve 380V AC seçenekleri mevcuttur.
Note: 12V DC, 24V DC, 220V AC and 380V AC options are available.

Model Model	Kapasite (Kcal/h) Capacity	Mak. Basınç Max. Pressure	Mak. Debi Max. Flow
2010	1.300	25 bar	40 lt/dk <i>l/min</i>
2015	6.000	25 bar	80 lt/dk <i>l/min</i>
2020	6.500	25 bar	90 lt/dk <i>l/min</i>
2024	12.000	25 bar	130 lt/dk <i>l/min</i>
2030	20.000	25 bar	130 lt/dk <i>l/min</i>
2040	25.000	25 bar	140 lt/dk <i>l/min</i>
2050	40.000	25 bar	190 lt/dk <i>l/min</i>
mini 608	1.050	25 bar	10 lt/dk <i>l/min</i>

WINMAN Sulu Soğutucular / Water Coolers



Kod Code	Yağ Debi Aralığı (l/dk) Oil Flow Range (l/min)	Kapasite (Kcal/h) Capacity
WWCE 80-3	10-30	1200-3000
WWCE 80-4	10-35	1300-3300
WWCE 80-5	20-60	2300-4200
WWCE 80-6	25-60	3300-5100
WWCE 80-7	30-60	3300-5800
WWCE 80-8	35-60	3350-6500
WWCE 80-9	35-70	4600-6850
WWCE 80-10	60-75	6100-7200
WWCE 80-11	60-80	6250-7800
WWCE 80-12	60-85	6400-8400
WWCE 130-6	25-60	3300-5100
WWCE 130-7	30-60	3300-5800
WWCE 130-8	35-60	3350-6500
WWCE 130-9	35-70	4600-6850
WWCE 130-10	60-75	6100-7200
WWCE 130-11	60-80	6250-7800
WWCE 130-13	30-85	6400-11000
WWCE 130-14	30-85	6700-13000
WWCE 130-15	30-85	7100-15000
WWCE 130-17	30-113	7400-17000
WWCE 130-18	30-113	8000-18000
WWCE 130-19	30-113	8600-19500
WWCE 130-21	30-113	9200-21500
WWCE 130-26	35-125	11300-26000
WWCE 150-14	30-85	6700-13000
WWCE 150-18	30-113	8000-18000
WWCE 150-22	30-120	9300-22000
WWCE 150-26	35-125	113000-26000
WWCE 150-30	35-125	127000-30000
WWCE 150-34	40-150	14500-34500
WWCE 150-38	40-150	18500-39000
WWCE 150-42	35-170	14000-31000
WWCE 155-40	35-170	14000-31000
WWCE 155-50	35-190	17000-35000
WWCE 155-60	40-220	20000-45000

WINMAN Güç Üniteleri (Power Packs) / Power Packs

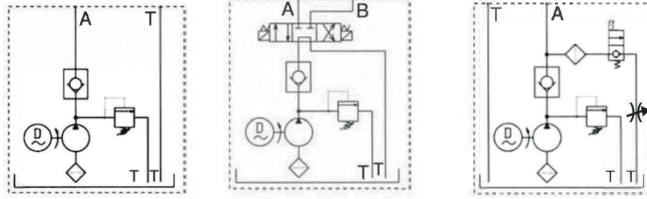
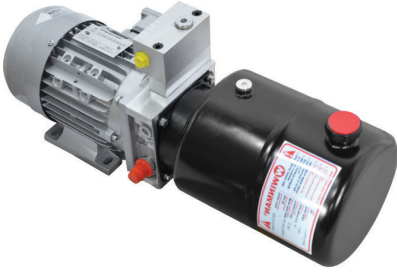

Tek etkili, P-T çıkışlı ve modüler valf montajlı çeşitleri bulunmaktadır.
 12V DC, 24V DC ve 300V AC seçenekleri bulunmaktadır.
 There are single-acting, P-T outlet and modular valve assembled types available.
 There are 12V DC, 24V DC and 300V AC options.

WINMAN Güç Üniteleri (Power Packs) / Power Packs

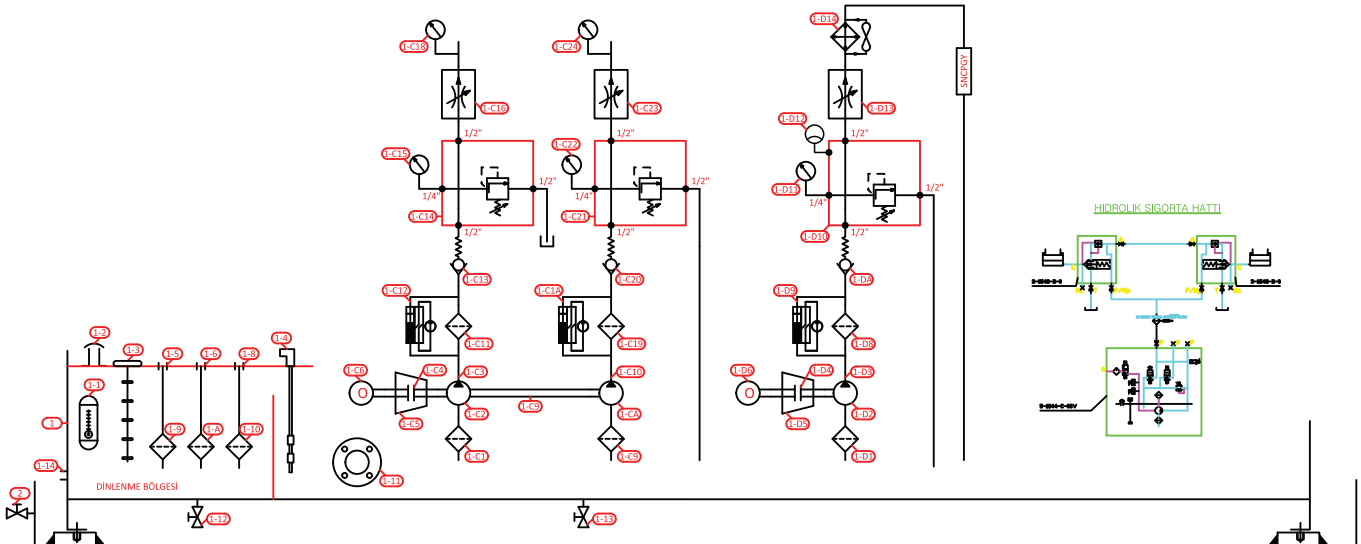
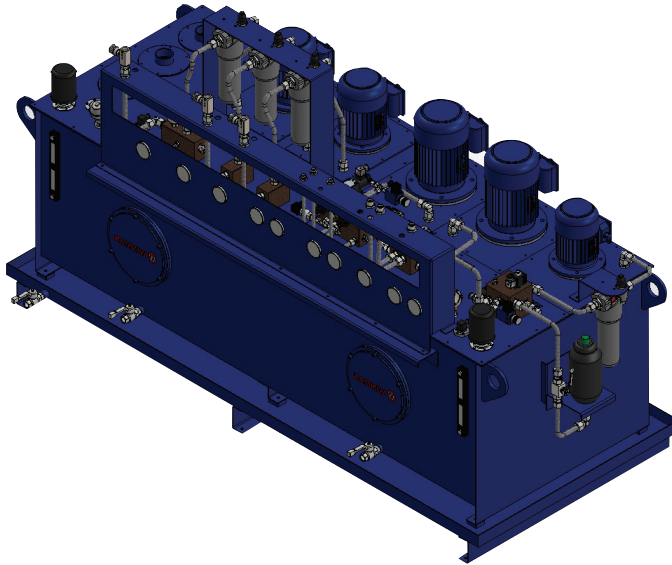

WINMAN Emiş Filtreleri

Suction Filters



Ölçü Size	Mak. Debi Max. Flow
1/4	5 lt/dk <i>l/min</i>
1	15-25-45 lt/dk <i>l/min</i>
1 1/2	65-90-125-180 lt/dk <i>l/min</i>
2	225-300-500 lt/dk <i>l/min</i>
3	750-1400 lt/dk <i>l/min</i>

WINMAN Dönüş Filtreleri

Return Filters



Ölçü Size	Filtrasyon Filtration	Mak. Basınç Max. Pressure
1/2	25	40 bar
3/4	25	80 bar
1	25	100 bar
1 1/4	25	214 bar
1 1/2	25	350 bar
2	25	500 bar

WINMAN Depo Kapakları

Tank Caps



Not: Mini, standart ve zincirli tipleri bulunmaktadır.
Note: There are mini, standard and chain types.

WINMAN Basınç Şalterleri

Pressure Switches



1/4 bağlantı
7-70, 5-600 bar aralıklarında
1/4 connection
7-70, 5-600 bar ranges

WINMAN Basınç Şalterleri

Pressure Switches



0-100, 0-400 bar aralıklarında
NA ve NC kontak seçenekleri
0-100, 0-400 bar ranges
NA and NC contact options

WINMAN Basınç Filtreleri

Pressure Filters



Ölçü Size	Filtrasyon Filtration	Mak. Basınç Max. Pressure	Mak. Debi Max. Flow
1/2	10	420 bar	35 lt/dk <i>l/min</i>
3/4	10	420 bar	55 lt/dk <i>l/min</i>
1	10	420 bar	80 lt/dk <i>l/min</i>
1/4	10	420 bar	300 lt/dk <i>l/min</i>

Manometreler

Manometers



Not: Ürün çeşitleri için bilgi alınır.

Note: Request information for product types.

Hidrolik Aküler

Hydraulic Batteries



Diyaframlı ve balonlu tipler bulunmaktadır.
0.05 ve 50 lt hacim aralıklarında
Maksimum basınç 350 bar
There are diaphragm and balloon types.
0.05 and 50 litre volume ranges
Maximum pressure 350 bar

WINMAN Seviye Şalterleri

Level Switches



100 mm ve 1000 mm aralıklarında
Between 100mm and 1000mm

WINMAN Basınç Transdüserleri

Pressure Transducers



0-10 V ve 4-20 mA kontak seçenekleri
0-5 bar ve 0-400 bar aralıklarında
1/4 bağlantı ölçüsü
0-10 V and 4-20 mA contact options
0-5 bar and 0-400 bar ranges
1/4 connection size

WINMAN Kaplinler
Couplings



DK24, DK28
DK32, DK38
DK42, DK48

Yıldız ve ayaklı kaplin çeşitleri bulunmaktadır.
There are star and footed coupling types.

WINMAN Kampanalar
Bellhousings



0K, 1K, 2K, kavi ve yuvarlak çeşitleri bulunmaktadır.
There are 0K, 1K, 2K, curved and round types.

WINMAN Yağ Seviye ve Sıcaklık Göstergeleri
Oil Level and Temperature Gauges



WINMAN Depo Bakım Kapağı
Tank Maintenance Cap



WINMAN Rakorlar
Fittings



WINMAN Hortum Rakorları
Hose Fittings



WINMAN Delik Körleme Tapaları
Expansion (Hole Blanking) Plugs



Ölçü Size
Ø3
Ø4
Ø5
Ø6
Ø8
Ø10

WINMAN Hortum Patlama Kartriçi ve Kovanı
Hose Burst Cartridges



Ölçü Size	Mak. Basınç Max. Pressure	Mak. Debi Max. Flow
1/4	350 bar	20 lt/dk <i>l/min</i>
3/8	350 bar	30 lt/dk <i>l/min</i>
1/2	350 bar	50 lt/dk <i>l/min</i>
3/4	350 bar	80 lt/dk <i>l/min</i>

WINMAN Hortumlar / Hoses



R1: Tek sıra dayanıklı çelik tel örgülü hortum -40°C'den +100°C'ye kadar hidrolik sistemler içindir.
R2: Çift kat çelik tel örgülü hortum -40°C'den +100°C'ye kadar tüm hidrolik sistemler içindir.
R9: 4 kat çelik tel örgülü hortum yüksek basınçlar için kullanılır.
R6: Genel endüstriyel ortamda ve pnömatik ekipmanlarda kullanılır.
Telli Şeffaf Hortum: Vakum hatları, yiyecek ve içecek taşıma, soğutma ve yakıt hatlarında kullanılır.

WINMAN PU Şeffaf Emiş Hortumu: Emiş hatlarında kullanılır ve et kalınlıklarına göre üretilir.
(Granül, toz, talaş, kağıt, tekstil ve aşındırıcı partiküllerin transferinde)

Teflon Hortumlar: -54°C'den +266°C'ye kadar sıcaklıkta esneklik gerektiren ve kimyasal dayanım yüksek olmasından dolayı birçok alanda tercih edilir.

Hortum Markalama Plakası: Sistemde çalışan hortumlarınızın, üretim durmasına gerek kalmadan, üzerinde yer alan barkodu bize bildirerek yeni hortumunuzu temin edebilirsiniz.

R1: Single row durable steel wire braided hose for hydraulic systems from -40°C to +100°C.

R2: Double layer steel wire braided hose is for all hydraulic systems from -40°C to +100°C.

R9: 4 layers of steel wire braided hose is used for high pressures.

R6: It is used in general industrial environment and pneumatic equipment.

Stranded transparent hose: Used in vacuum lines, food and beverage transport, cooling and fuel lines.

WINMAN PU Transparent Suction Hose: It is used in suction lines and produced according to the wall thickness.
(Transfer of granules, dust, wood chips, paper, textiles and abrasive particles)

Teflon Hoses: They are preferred in many areas as they require flexibility at temperatures from -54°C to +266°C and because of their high chemical resistance.

Hose Marking Plate: You can supply your new hose by informing us the barcode on your hoses working in the system without the need for production to stop.

WINMAN Silindir Boruları
Cylinder Tubes



Ø 25 x 35 ve Ø 220 x 245,5 aralıklarında
Between Ø 25 x 35 and Ø 220 x 245,5

WINMAN Devre Boruları
Lining Tubes



Ø 6 x 1 ve Ø 42 x 4 aralıklarında
Fosfat ve galvaniz seçenekleri bulunmaktadır.
Between Ø 6 x 1 and Ø 42 x 4
There are phosphate and galvanize options.

WINMAN Döküm Miller
Casting Bars



GG25 yuvarlak Ø 50 ve Ø 250 aralıklarında
GG25 kare 50 x 50 ve 200 x 200 aralıklarında
GG25 dikdörtgen 60 x 90 ve 150 x 110 aralıklarında
GGG yuvarlak Ø 80 ve Ø 190 aralıklarında
GGG kare 60 x 60 ve 160 x 160 aralıklarında
GGG dikdörtgen 100 x 80 ve 170 x 130 aralıklarında
GG25 round ranges between Ø 50 and Ø 250
GG25 square ranges between 50 x 50 and 200 x 200
GG25 rectangle ranges between 60 x 90 and 150 x 110
GGG round ranges between Ø 80 and Ø 190
GGG square ranges between 60 x 60 and 160 x 160
GGG rectangle ranges between 100 x 80 ve 170 x 130

WINMAN İndüksiyonlu Krom Kaplı Miller
Induction Chrome Coated Bars

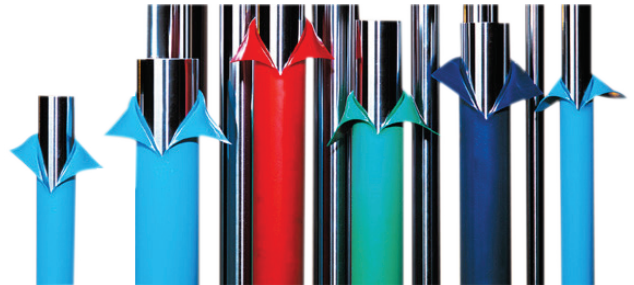

Ø 4 ve Ø 250 aralıklarında
Özel ölçüler için bilgi alınız.
Between Ø 4 and Ø 250
Obtain information for special measurements.

Basınç Yükselticiler / Pressure Intensifiers



Mak. Giriş Debisi Max. Inlet Flow	Çıkış Debisi Q1 Output Flow Q1	Çıkış Debisi Q2 Output Flow Q2	Mak. Giriş Basıncı Max. Inlet Pressure	Mak. Çıkış Basıncı Max. Outlet Pressure
35 lt/dk <i>l/min</i>	4	2.4	200 bar	800 bar
8 lt/dk <i>l/min</i>	0.8	0.2	200 bar	400 bar
15 lt/dk <i>l/min</i>	2.2	0.5	200 bar	680 bar
14 lt/dk <i>l/min</i>	1.8	0.4	200 bar	800 bar
14 lt/dk <i>l/min</i>	1.4	0.3	160 bar	800 bar
12 lt/dk <i>l/min</i>	0.7	0.2	200 bar	2000 bar

Kumanda Kolları / Levers

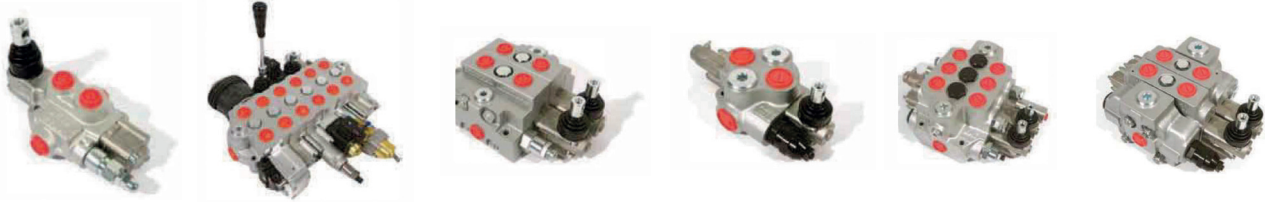

Tekli, ikili, üçlü, dördü, beşli, altılı, yedili, dıımlı ve monoblok tipleri bulunmaktadır.
40 lt/dk, 50 lt/dk, 70 lt/dk, 90 lt/dk, 130 lt/dk geçirgenlik değerlerine sahiptir.
There are single, double, triple, quadruple, quinary, senary, septet, sliced and monoblock types.
It has permeability values of 40 l/min, 50 l/min, 70 l/min, 90 l/min, 130 l/min.

Isı Kılıfları / High Temperature Hose Sleeve



CAM ELYAF ÖRGÜLÜ KILIF / FIBER GLASS SLEEVE

Mak. Çalışma Sıcaklığı Max. Working Temperature	Sürekli Çalışma Sıcaklığı Continuous Working Temperature	Rulo Uzunluğu Roll Length
705 °C	538 °C	30m



İÇ SICAKLIK İZOLASYON KILIFI / HEAT ISOLATION SLEEVE

Mak. Uygulama Sıcaklığı Max. Application Temperature	Sıcaklık İzole Oranı Temperature Insulation Rate	Rulo Uzunluğu Roll Length
316 °C	1/3	30m



İLİK KAPAKLI - CIRT BANTLI SİLİKON KILIF / BUTTONHOLE COVER - VELCRO BANDED SILICONE SLEEVE

Mak. Çalışma Sıcaklığı Max. Working Temperature	Sıcaklık İzole Oranı Temperature Insulation Rate	Rulo Uzunluğu Roll Length	Rulo Uzunluğu Roll Length
1650 °C	1090 °C	260 °C	Metre ve Katları Metre and Multiples

Boru Kelepçeleri / Pipe Clamps



Tekli, ikiz ve ağır seri çeşitleri bulunmaktadır.
There are single, twin and heavy series types.

A series of horizontal dotted lines spanning the width of the page, intended for writing notes.



HİD-TEK LTD. ŞTİ.

Üçevler Mah. Ünalp Sok. No: 1/A
Nilüfer / BURSA / TÜRKİYE
Tel: 0 224 443 16 20
Fax : 0 224 443 16 37

İkitelli / İSTANBUL
Tel : 0 212 549 98 36
Fax : 0 212 549 98 39

İmes / İSTANBUL
Tel : 0 216 365 70 71
Fax : 0 216 365 70 72

Bornova / İZMİR
Tel : 0 232 433 54 44
Fax : 0 232 433 00 31

Karatay / KONYA
Tel : 0 332 345 03 00
Fax : 0 332 345 03 24

İzmit / KOCAELİ
Tel : 0 262 335 60 10
Fax : 0 262 335 60 11

Yenimahalle/ ANKARA
Tel : 0 312 394 83 64
Fax : 0 312 394 83 66

Plovdiv / BULGARİSTAN
Tel : +359 32 941 963
Fax : +359 32 941 970